

MOTOR-PUMP PETROL

HY50-A-2 / HY80-A-2

ORIGINAL INSTRUCTIONS

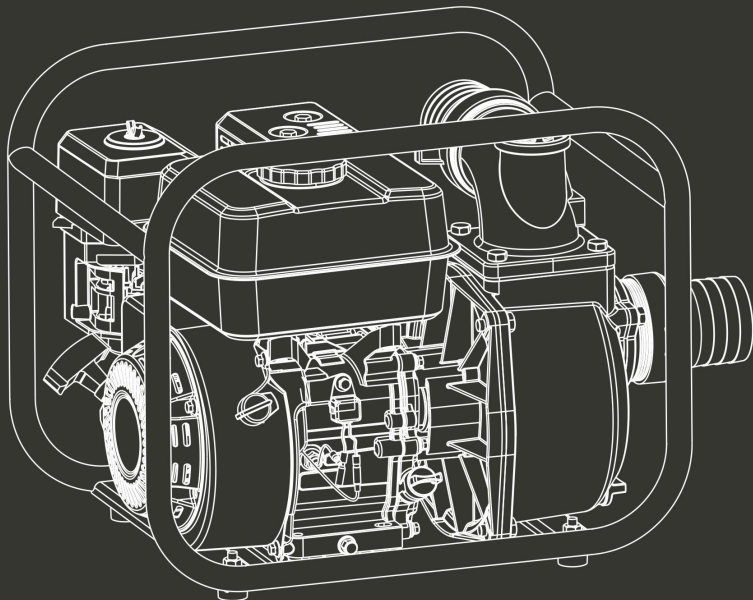

WARNING: Read thoroughly the instruction manual before use

Intended use

This thermal water pump is intended to be used mainly for drainage, evacuation and transfer of water, drawing and evacuation of water and boats or, for a limited time, to circulation and re-oxygenation of water.

Any other use not expressly permitted in this manual may result in damage to the device, may be a serious hazard to the user and is not permitted.

This machine must NEVER be used:

- For professional use or agriculture
- For public gardens or forest maintenance
- By children fewer than 16 and unaccompanied minors

Please observe carefully all the notes, explanations and instructions in this manual for optimum and safe use of this machine.

This machine is intended for private and domestic use.

Any misuse can cause accidents and malfunction of the machine. Follow the instructions in this manual to use the tool correctly.

SAFETY INFORMATION

Read and understand this owner's manual before operating your water pump. You can help prevent accidents by being familiar with your water pump's controls, and by observing safe operating procedures.

Operator Responsibility

- Know how to stop the engine quickly in case of emergency.
- Understand the use of all water pump controls.
- Do not let children operate the water pump without parental supervision. Keep children and pets away from the area of operation.

- This pump CAN NOT be used for dirty water and sea water.

Refuel With Care

Gasoline is extremely flammable, and gasoline vapor can explode. Refuel outdoors, in a well-ventilated area, with the engine stopped. Never smoke near gasoline, and keep other flames and sparks away.

Hot Exhaust

- The muffler becomes very hot during operation and remains hot for a while after stopping the engine. Be careful not to touch the muffler while it is hot. Let the water pump cool before storing it indoors.
- To prevent fire hazards, keep the water pump at least 3 feet (1meter) away from building walls and other equipment during operation.

Carbon Monoxide Hazards

- Exhaust contains poisonous carbon monoxide, a colorless and odorless gas. Breathing exhaust directly can cause loss of consciousness and may lead to death.
- If you run the water pump in an area that is confined, the air you breathe could contain a dangerous amount of exhaust gas. To keep exhaust gas from accumulating, provide adequate ventilation.

CONTROLS & FEATURES

COMPONENT & CONTROL LOCATION

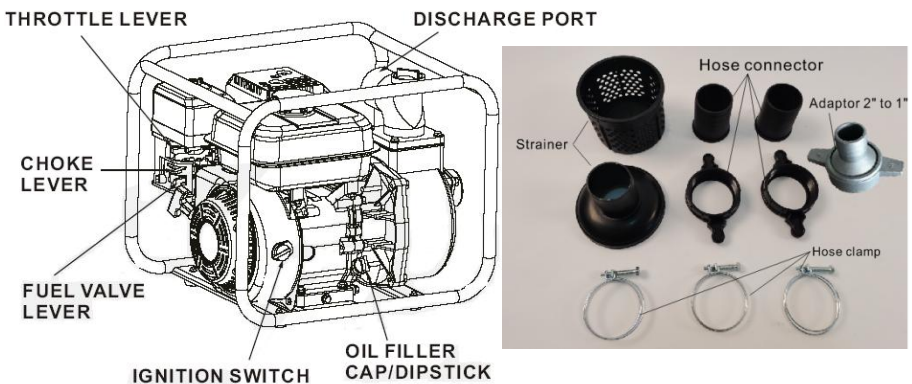

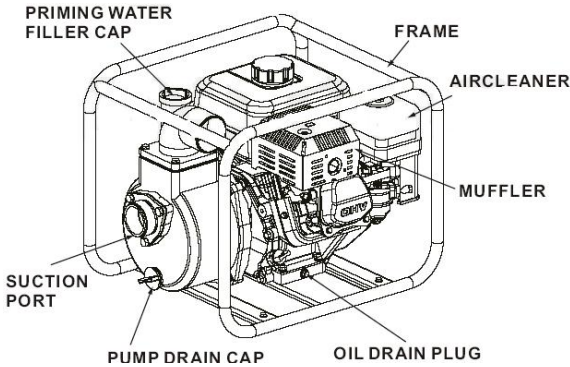

CONTROLS

Fuel Valve Lever

The fuel valve opens and closes the passage between the fuel tank and the carburetor.

The fuel valve lever must be in the **ON** position for the engine to run.

When the engine is not in use, leave the fuel valve lever in the **OFF** position to prevent carburetor flooding and to reduce the possibility of fuel leakage.

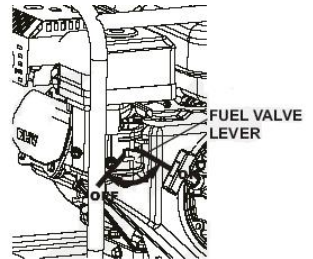

Engine Switch

The engine switch enables and disables the ignition system.

The engine switch must be in the **ON** position for the engine to run.

Turning the engine switch to the **OFF** position stops the engine.

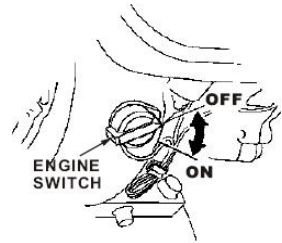

Choke Lever

The choke lever opens and closes the choke valve in the carburetor.

The **CLOSED** position enriches the fuel mixture for starting a cold engine.

The **OPEN** position provides the correct fuel mixture for operation after starting, and for restarting a warm

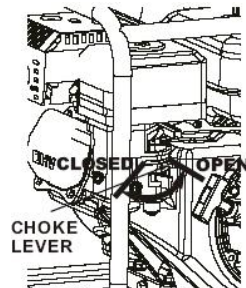

engine.

Throttle Lever

The throttle lever controls engine speed.

Moving the throttle lever in the directions shown makes the engine run faster or slower.

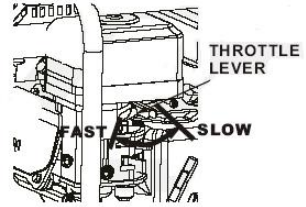

Recoil Starter Grip

Pulling the starter grip operates the recoil starter to crank the engine.

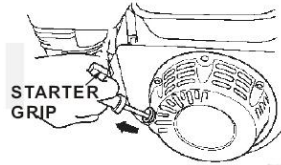

FEATURES

Oil Alert System

The Oil Alert system is designed to prevent engine damage caused by an insufficient amount of oil in the crankcase.

Before the oil level in the crankcase can fall below a safe limit, the Oil Alert system will automatically stop the water pump.

BEFORE OPERATION CHECKS

Check the Suction and Discharge Hoses

- Remember that the suction hose must be reinforced construction to prevent hose collapse.
- Check that the sealing washer in the suction hose connector is in good condition.
- Check that the hose connectors and clamps are securely installed.
- Check that the strainer is in good condition and is installed on the suction hose.

Check the Engine

- Check the oil level.
- Check the air filter.
- Check the fuel level.

OPERATION

PUMP PLACEMENT

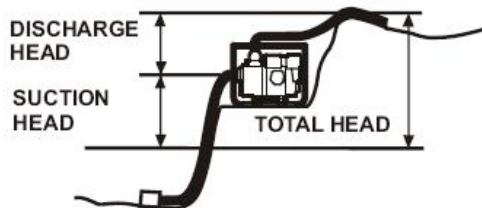

For best pump performance, place the pump near the water level, and use hose that are no longer than necessary. That will enable the pump to produce the greatest output with the least self-priming time.

As head (pumping height) increases, pump output decrease. The length, type, and size of the suction and discharge hoses can also significantly affect pump output. Minimizing suction head (placing the pump near the water lever) is also very important for reducing self-priming time. Self-priming time is the time it takes the pump to bring water the distance of the suction head during initial operation.

SUCTION HOSE INSTALLATION

Do not use a hose smaller than the pump's suction port size **except with an adaptor provided by manufacturer.**

Pump performance is best when the pump is near the water level, and the hoses are short.

Minimum hose size: 50 mm

This model with adaptor of sucking hose and delivery hose (HY50-A-2 with adaptor 2" to 1"; HY80-A-2 with adaptor 3" to 1"), hose 25mm can be used.

Use a hose clamp to securely fasten the hose connector to the suction hose in order to prevent air leakage and loss of suction. Verify that the hose connector sealing washer is in good condition.

Install the strainer on the other end of the suction hose, and secure it with a hose clamp. The strainer will help to prevent the pump from becoming clogged or damaged by debris.

Securely tighten the hose connector on the pump suction port.

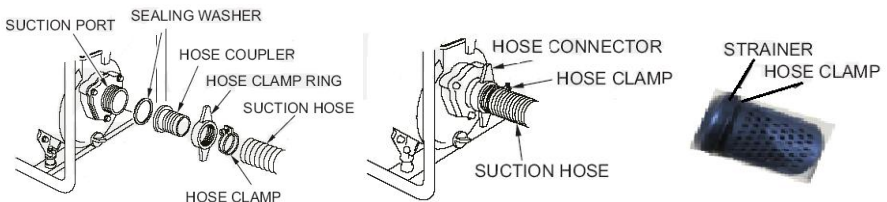

DISCHARGE HOSE INSTALLATION

It is best to use a short, large-diameter hose, because that will reduce fluid friction and improve pump output.

Tighten the hose clamp securely to prevent the discharge hose from disconnecting under pressure.

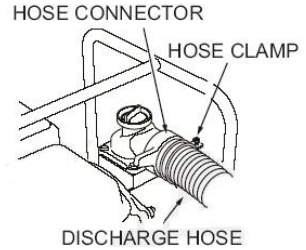

PRIMING THE PUMP

Before starting the engine, remove the filler cap from the pump chamber, and completely fill the pump chamber with water. Reinstall the filler cap, and tighten it securely.

NOTICE

Operating the pump dry will destroy the pump seal. If the pump has been operated dry, stop the engine immediately and allow the pump to cool before priming.

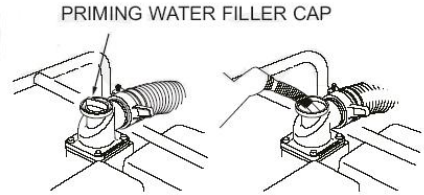

STARTING THE ENGINE

1. Prime the pump.
2. Move the fuel valve lever to the **ON** position.
3. To start a cold engine, move the choke lever to the **CLOSED** position.

To restart a warm engine, leave the choke lever in the **OPEN** position.

4. Move the throttle lever from the **SLOW** position about 1/3 of the way toward the **FAST** position.

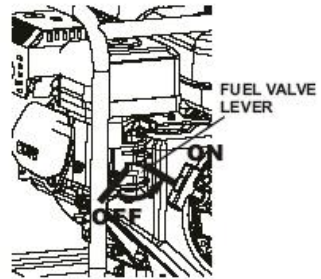

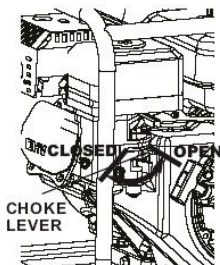
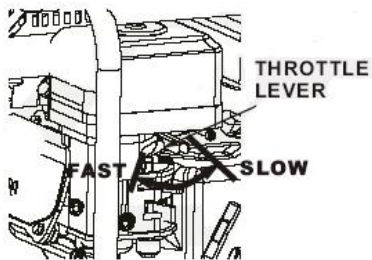

5. Turn the engine switch to the **ON** position.

6. Operate the starter.

Pull the starter grip lightly until you feel resistance, then pull briskly.

Return the starter grip gently.

7. If the choke lever has been moved to the **CLOSED** position to start the engine, gradually move it to the **OPEN** position as the engine warms up.

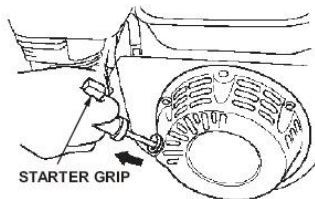
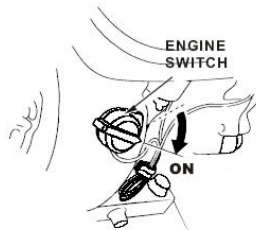

STOPPING THE ENGINE

To stop the engine in an emergency, simply turn the engine switch to the **OFF** position.

Under normal conditions, use the following procedure.

1. Move the throttle lever to the **SLOW** position.
2. Turn the engine switch to the **OFF** position.
3. Turn the fuel valve lever to the **OFF** position.

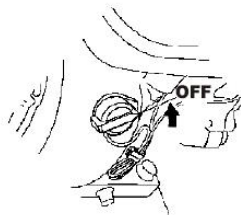
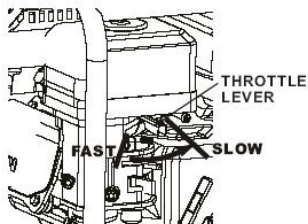
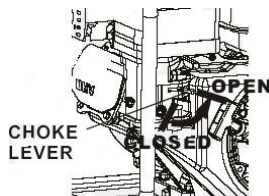

SETTING ENGINE SPEED

Position the throttle lever for the desired engine speed.

For engine speed recommendations, refer to the instructions provided with the equipment powered by this engine.

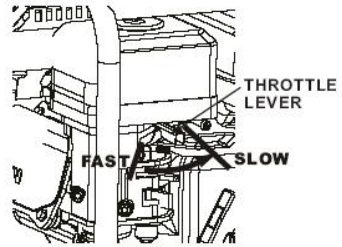

SERVICING YOUR PUMP

If you operate your water pump under severe conditions, such as sustained high-load or high-temperature operation, or use in unusually wet or dusty conditions, consult your technician for recommendations applicable to your individual needs and use.

To ensure the best quality and reliability, use only new, genuine parts or their equivalents for repair and replacement.

SAFETY PRECAUTIONS

Make sure the engine is off before you begin any maintenance or repair.

This will eliminate several potential hazards:

- Carbon monoxide poisoning from engine exhaust.

Be sure there is adequate ventilation whenever you operate the water pump.

- Burns from hot parts.

Let the water pump cool before touching.

- Injury from moving parts.

Do not run the water pump unless instructed to do so.

Read the instructions before you begin, and make sure you have the tools and skills required.

To reduce the possibility of fire or explosion, be careful when working around gasoline. Use only a nonflammable solvent, not gasoline, to clean parts. Keep cigarettes, sparks and flames away from all fuel related parts.

Remember that a technician knows your water pump best and is fully equipped to maintain and repair it.

MAINTENANCE SCHEDULE

Service period Item	Each use	20Hrs. or First monty (3)	50Hrs. or Every 3 months (3)	100Hrs. or Every 6 months (3)	300Hrs. or Every 1 year (3)
● Engine oil	Check				
		Change		Change	
● Air filter	Check				
			Clean(1)	Clean(1)	
● Sediment cup				Clean	
● Spark plug				Check Adjust	
					Change
● Idle speed					Check Adjust (2)
● Valve clearance			Check Adjust		Check Adjust (2)
● Combustion Chamber	After every 500 Hrs(2)				
● Fuel tank				Clean(2)	
● Fuel filter				Clean(2)	
● Fuel tube	Every 2 years (Replace if necessary) (2)				
Impeller					Check (2)
Impeller clearance					Check (2)
Pumpinlet valve					Check (2)

- Emission related items.

(1) Service more frequently when used in dusty areas.

(2) These items should be serviced by an technician.

(3) For commercial use, log hours of operation to determine proper maintenance intervals.

REFUELING

Use unleaded gasoline with a pump octane rating of 86 or higher.

Unleaded gasoline produces fewer engine and spark plug deposits and extends exhaust system life.

WARNING !

Gasoline is highly flammable and explosive, and you can be burned or seriously injured when refueling.

- **Stop engine and keep heat, sparks, and flame away.**
- **Refuel only outdoors.**
- **Wipe up spills immediately.**

Adding Fuel

1. Remove the fuel tank cap.
2. Add fuel to the bottom of the fuel level limit in the neck of the fuel tank.

Do not overfill. Wipe up spilled fuel before starting the water pump.

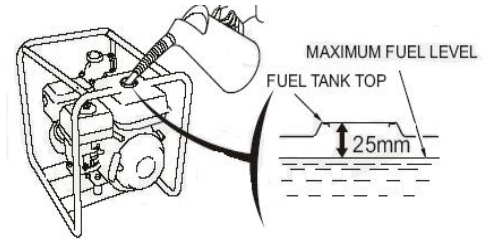

ENGINE OIL LEVEL CHECK

Check the engine oil level with the engine stopped and in a level position.

1. Remove the filler cap/dipstick and wipe it clean.
2. Insert and remove the dipstick without screwing it into the filler neck.

Check the oil level shown on the dipstick.

3. If the oil level is low, fill to the edge of the oil filler hole with the recommended oil.
4. Screw in the filler cap/dipstick securely.

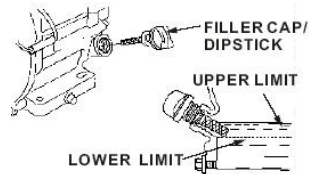

ENGINE OIL CHANGE

Drain the used oil while the engine is warm. Warm oil drains quickly and completely.

Warning! Pay attention that the engine oil may be very hot if it is drained off directly after the engine is shut off, or allow the engine to cool a few minutes before draining the oil.

1. Place a suitable container below the engine to catch the used oil, then remove the filler cap/dipstick, drain plug, and washer.
2. Allow the used oil to drain completely, then reinstall the drain plug, washer, and tighten drain plug securely.

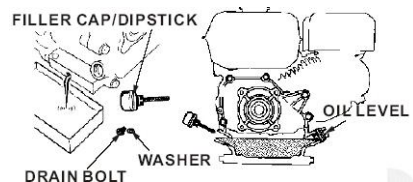

3. With the engine in a level position, fill to the outer edge of the oil filler hole with the recommended oil .
4. Screw in the filler cap/dipstick securely.

ENGINE OIL RECOMMENDATIONS

Oil is a major factor affecting performance and service life. Use 4-stroke automotive detergent oil.SAE 10W-30 is recommended for general use.

Warning! We suggest you take used oil in a sealed container to your local recycling center or service station for reclamation. Do not throw it in the trash, pour it on the ground, or down a drain as the oil or gasoline concerning the toxicity.

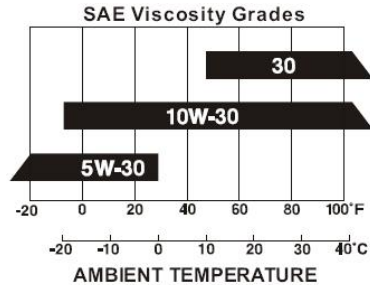

AIR CLEANER SERVICE

A dirty air filter will restrict air flow to the carburetor, reducing engine performance. If you operate the engine in very dusty areas, clean the air filter more often than specified in the MAINTENANCE SCHEDULE.

NOTICE

Operating the engine without an air filter, or with a damaged air filter, will allow dirt to enter the engine, causing rapid engine wear.

Dual Filter Element Types

1. Remove the wing nut from the air cleaner cover, and remove the cover.
2. Remove the wing nut from the air filter, and remove the filter.
3. Remove the foam filter from the paper filter.
4. Inspect both air filter elements, and replace them if they are damaged.

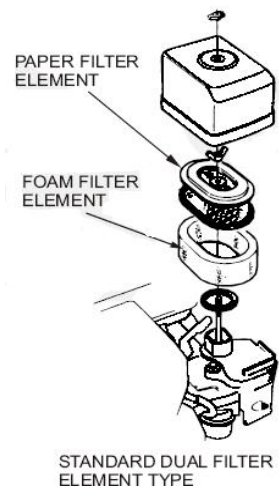

5. Clean the air filter elements if they are to be reused.

Paper air filter element: Tap the filter element several times on a hard surface to remove dirt.

Never try to brush off dirt; brushing will force dirt into the fibers.

Foam air filter element: Clean in warm soapy water, rinse, and allow to dry thoroughly.

Dip the filter element in clean engine oil, then squeeze out all excess oil.

6. Wipe dirt from the inside of the air cleaner base and cover, using a moist rag.

7. Place the foam air filter element over the paper element, and reinstall the assembled air filter. Be sure the gasket is in place beneath the air filter. Tighten the air filter wing nut securely.

8. Install the air cleaner cover, and tighten the cover wing nut securely.

SEDIMENT CUP CLEANING

1. Move the fuel valve to the **OFF** position, then remove the fuel sediment cup and O-ring.

2. Wash the sediment cup and O-ring in nonflammable solvent, and dry them thoroughly.

3. Place the O-ring in fuel valve, and install the sediment cup. Tighten the sediment securely.

4. Move the fuel valve to the **ON** position, and check for leaks. Replace the O-ring if there is any leakage.

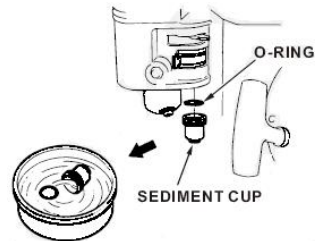

SPARK PLUG SERVICE

Recommended spark plug: F6RTC

1. Disconnect the spark plug cap, and remove any dirt from around the spark plug area.

2. Remove the spark plug with a spark plug wrench.

3. Inspect the spark plug. Replace it if the electrodes are worn, or if the insulator is cracked or chipped.

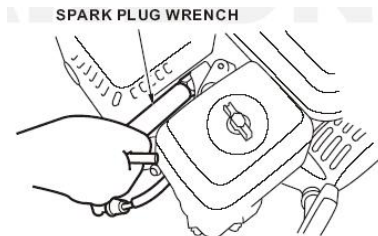

4. Measure the spark plug electrode gap with a suitable gauge. The gap should be 0.028~0.031 in (0.70~0.80mm). Correct the gap if necessary, by carefully bending the side electrode.
 5. Install the spark plug carefully, by hand, to avoid cross-threading.
 6. After the spark plug seats, tighten with a spark plug wrench to compress the sealing washer.
- If reinstalling the used spark plug, tighten 1/8-1/4 turn after the spark plug seats.
If installing a new spark plug, tighten 1 / 2 turn after the spark plug seats.

NOTICE

A loose spark plug can overhand and damage the engine.

Overtightening the spark plug can damage the threads in the cylinder head.

7. Attach the spark plug cap.

STORING YOUR WATER PUMP

Storage Preparation

Proper storage preparation is essential for keeping your water pump troublefree and looking good.

Cleaning

If the water pump has been running, allow it to cool for at least half an hour before cleaning. Clean all exterior surfaces, touch up any damaged paint, and coat other areas that may rust with a light film of oil.

Fuel

Gasoline will oxidize and deteriorate in storage. Old gasoline will cause hard starting, and it leaves gum deposits that clog the fuel system.

If the gasoline in your water pump deteriorates during storage, you may need to have the carburetor and other fuel system components serviced or replaced.

You can extend fuel storage life by adding a fuel stabilizer, or you can avoid fuel deterioration problems by draining the fuel tank and carburetor.

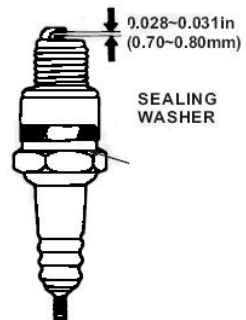

ADDING A FUEL STABILIZER TO EXTEND FUEL STORAGE LIFE

When adding a fuel stabilizer, fill the fuel tank fresh gasoline.

1. Add fuel stabilizer following the manufacturer's instructions.
2. After adding a fuel stabilizer, run the water pump outdoors for 10 minutes to be sure that treated gasoline has replaced the untreated gasoline in the carburetor.
3. Stop the engine, and move the fuel valve to the **OFF** position.

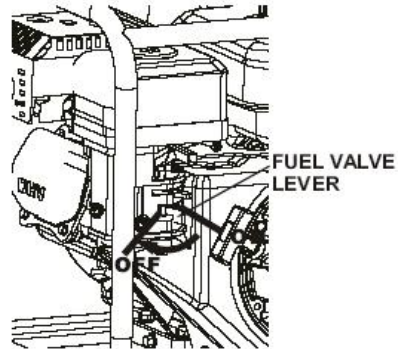

DRAINING THE FUEL AND CARBURETOR

1. Place an approved gasoline container below the carburetor, and use a funnel to avoid spilling fuel.
2. Remove the carburetor drain bolt and sediment cup, then move the fuel valve lever to the ON position.

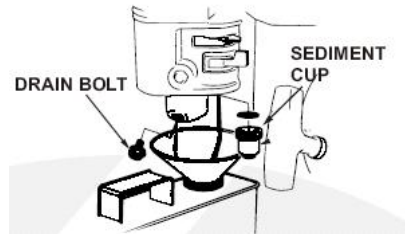

ENGINE OIL

1. Change the engine oil.
2. Remove the spark plugs.
3. Pour a tablespoon (5~10cc) of clean engine oil into the cylinder.
4. Pull the starter rope several times to distribute the oil in the cylinder.
5. Reinstall the spark plug.
6. Pull the starter rope slowly until resistance is felt. This will close the valves so moisture cannot enter the engine cylinder. Return the starter rope gently.

Storage Precautions

Select a well ventilated storage area away from any appliance that operates with a flame, such as a furnace, water heater, or clothes dryer.

Also avoid any area with a spark-producing electric motor, or where power tools are operated.

If possible, avoid storage areas with high humidity, because that promotes rust and corrosion.

Unless all fuel has been drained from the fuel tank, leave the fuel valve lever in the OFF position to reduce the possibility of fuel leakage.

With the engine cool, cover the engine to keep out dust.

Do not use sheet plastic as a dust cover. A nonporous cover will trap moisture around the engine, promoting rust and corrosion.

Removal From Storage

Check your engine as described in the BEFORE OPERATION chapter of this manual.

If the fuel was drained during storage preparation, fill the tank with fresh gasoline.

Gasoline oxidizes and deteriorates over time, causing hard starting.

TRANSPORTING

This machine must be kept in a equilibrium position, can not be side turn during the transport

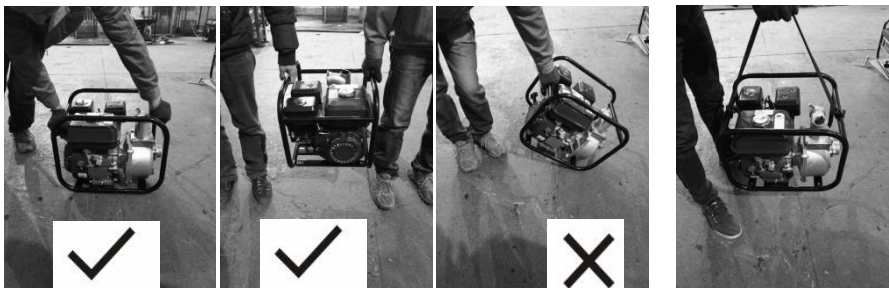

In the figure below, the center of gravity of the machine is suitable for the lifting position of the machine.

If the engine has been running, allow it to cool for at least 15 minutes before loading the engine-powered equipment on the transport vehicle. A hot engine and exhaust system can burn you and can ignite some materials.

Keep the engine level when transporting to reduce the possibility of fuel leakage.
 Move the fuel valve lever to the **OFF** position.

TAKING CARE OF UNEXPECTED PROBLEMS

ENGINE WILL NOT START

ENGINE WILL NOT START	Possible Cause	Correction
1. Check control positions.	Fuel valve OFF.	Move lever to ON.
	Choke OFF.	Move the choke / throttle lever to CHOKE ON position unless engine is warm.
	Ignition switch OFF.	Move the throttle lever to FAST position.
2. Check fuel.	Out of fuel.	Refuel
	Bad fuel; engine stored without treating or draining gasoline, of refueled with bad gasoline.	Drain the fuel tank and carburetor. Refuel with fresh gasoline.
3. Remove and inspect spark plug.	Spark plug faulty, fouled, or improperly gapped.	Replace the spark plug.
	Spark plug wet with fuel (flooded engine).	Dry and reinstall spark plug. Start engine with choke / throttle lever in FAST position.
4. Take engine to a technician.	Fuel filter clogged, carburetor malfunction, ignition malfunction, valves stuck, etc.	Replace or repair faulty components as necessary.

ENGINE LACKS POWER

ENGINE LACKS POWER	Possible Cause	Correction
1. Check air cleaner.	Air cleaner elements clogged.	Clean or replace air cleaner elements.

2. Check fuel.	Bad fuel; engine stored without treating or draining gasoline, or refueled with bad gasoline.	Drain the fuel tank and carburetor. Refuel with fresh gasoline.
3. Take engine to a technician.	Fuel filter clogged, carburetor malfunction, ignition malfunction, valves stuck, etc.	Replace or repair faulty components as necessary.

NO PUMP OUTPUT

NO PUMP OUTPUT	Possible Cause	Correction
1. Check pump chamber.	Pump not primed.	Prime pump.
2. Check suction hose.	Hose collapsed, cut or punctured.	Replace suction hose.
	Strainer not completely underwater.	Sink the strainer and the end of a suction hose completely underwater.
	Air leak at connector.	Replace sealing washer if missing or damaged. Tighten hose connector and clamp.
	Strainer clogged.	Clean debris from strainer.
3. Measure suction and discharge head.	Excessive head.	Relocate pump and / or hoses to reduce head.
Check engine.	Engine lacks power.	See page 16.

LOW PUMP OUTPUT

LOW PUMP OUTPUT	Possible Cause	Correction
1. Check suction hose.	Hose collapsed, damaged, too long, or diameter too small.	Replace suction hose.
	Air leak at connector.	Replace sealing washer if missing or damaged. Tighten hose connector and clamp.
	Strainer clogged.	Clean debris from strainer.
2. Check discharge hose.	Hose damaged, too long, or diameter too small	Replace discharge hose.
3. Measure suction and discharge head.	Marginal head.	Relocate pump and / or hoses to reduce head.
4. Check engine.	Engine lacks power.	See page 16.

SPECIFICATIONS

Engine design and performance (HY50-A-2)

Model	PT170F
Engine type	4-stroke, OHV, single cylinder
Displacement	212 cc
Bore×stroke	70× 55 mm
Fuel tank capacity	3.2L
Rated output	4.0kW/3600/min
Engine oil capacity	0.6l
Fuel consumption	395g/kW.h
Cooling system	Forced air cooling
Ignition system	Transistorized magneto
PTO shaft rotation	Counterclockwise

Pump (HY50-A-2)

Max. Head	30m
Suction head	7m
Flow	33m ³ /h
Diameter of suction pipe	50mm
Diameter of discharge pipe	50mm
Engine type	PT170F
Rated output power	3.2kW/3600/min
Net weight	22kg
Max. Permissible pressure	0.25MPa
Measured sound pressure level	88.7dB(A)
Measured sound power level	101.6dB(A), K=4.42 dB(A)
Guaranteed sound power level	106dB(A)

Engine design and performance (HY80-A-2)

Model	PT170F
Engine type	4-stroke, OHV, single cylinder
Displacement	212 cc
Bore×stroke	70× 55 mm
Fuel tank capacity	3.2L
Rated output	4.0kW/3600/min
Engine oil capacity	0.6l
Fuel consumption	395g/kW.h
Cooling system	Forced air cooling
Ignition system	Transistorized magneto
PTO shaft rotation	Counterclockwise

Pump (HY80-A-2)

Max. Head	28m
Suction head	7m
Flow	60m ³ /h
Diameter of suction pipe	80mm
Diameter of discharge pipe	80mm
Engine type	PT170F
Rated output power	3.65kW/3600/min
Net weight	24kg
Max. Permissible pressure	0,25 MPa
Measured sound pressure level	91 dB(A)
Measured sound power level	104,8 dB(A) k=2.32dB(A)
Guaranteed sound power level	106 dB(A)

Safety label

Explanation of warning labels



Read the instruction manual before using the machine



Keep bystanders away



Caution! Do not use the machine indoors.



Risk of high temperature



Do not touch the high temperature



No naked flames



hearing protection must be worn

Piping diagrams

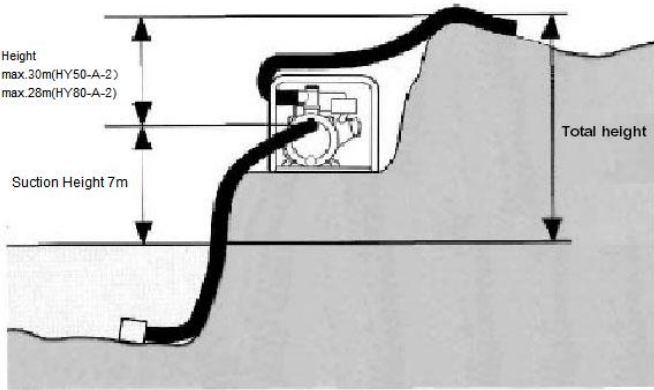

Measuring point

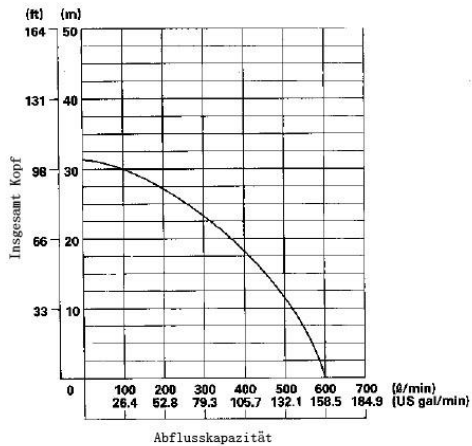



Declaration of conformity

BUILDER SAS

ZI, 32 rue aristide Bergès - 31270 Cugnaux - France

Declares that the machine designated below:

MOTOR-PUMP PETROL

Ref: HY50-A-2/HY80-A-2

Serial number:

HY50-A-2: 20220525111-20220525200

HY80-A-2: 20220525201-20220525450

Complies with the provisions of the Machine Directive 2006/42 / EC and the national regulations transposing it;

Also complies with the provisions of the following European Directives:

To the EMC Directive 2014/30 / EU

Emission directive (EU)2016/1628+2017/656

Directive on noise emission in the environment of equipment intended for use outside buildings 2000/14 / EC & 2005/88 / EC

Also complies with European standards, national standards and the following technical provisions:

- EN 809: 1998 / A1: 2009; EN ISO 12100: 2010
 - EN ISO 3744: 1995
- EN 55012: 2007 / A1: 2009
- EN 61000-6-1: 2007

Done at Cugnaux on 31/03/2022

Philippe MARIE / PDG

WARRANTY

HYUNDAI

WARRANTY

The manufacturer guarantees the product against defects in material and workmanship for a period of 2 years from the date of the original purchase. The warranty only applies if the product is for household use. The warranty does not cover breakdowns due to normal wear and tear.

The manufacturer agrees to replace parts identified as defective by the designated distributor. The manufacturer does not accept responsibility for the replacement of the machine, in whole or in part, and/or ensuing damage.

The warranty does not cover breakdowns due to:

- insufficient maintenance.
- abnormal assembly, adjustment or operations of the product.
- parts subject to normal wear and tear.

The warranty does not extend to:

- shipping and packaging costs.
- using the tool for a purpose other than that for which it was designed.
- the use and maintenance of the machine done in a manner not described in the user manual.

Due to our policy of continuous product improvement, we reserve the right to alter or change specifications without notice. Consequently, the product may be different from the information contained therein, but a modification will be undertaken without notice if it is recognized as an improvement of the preceding characteristic.

READ THE MANUAL CAREFULLY BEFORE USING THE MACHINE.

When ordering spare parts, please indicate the part number or code, you can find this in the spare parts list in this manual. Keep the purchase receipt; without it, the warranty is invalid. To help you with your product, we invite you to contact us by phone or via our website:

- **+33 (0)9.70.75.30.30**
- **<https://services.swap-europe.com/contact>**

You must create a "ticket" via the web platform.

- Register or create your account.
- Indicate the reference of the tool.
- Choose the subject of your request.
- Describe your problem.
- Attach these files: invoice or sales receipt, photo of the identification plate (serial number), photo of the part you need (for example: pins on the transformer plug which are broken).



PRODUCT FAILURE

WHAT TO DO IF MY MACHINE BREAKS DOWN?

If you bought your product in a store:

- a) Empty the fuel tank if your product has one.
- b) Make sure that your machine is complete with all accessories supplied, and clean! If this is not the case, the repairer will refuse the machine.

Go to the store with the complete machine and with the receipt or invoice.

If you bought your product on a website:

- a) Empty the fuel tank if your product has one..
- b) Make sure that your machine is complete with all accessories supplied, and clean! If this is not the case, the repairer will refuse the machine.
- c) Create a SWAP-Europe service ticket on the site: <https://services.swap-europe.com> When making the request on SWAP-Europe, you must attach the invoice and the photo of the nameplate (serial number).
- d) Contact the repair station to make sure it is available before dropping off the machine.

Go to the repair station with the complete machine packed, accompanied by the purchase invoice and the station support sheet downloadable after the service request is completed on the SWAP-Europe site

For machines with engine failure from manufacturers BRIGGS & STRATTON, HONDA and RATO, please refer to the following instructions.

Repairs will be done by approved engine manufacturers of these manufacturers, see their site:

- <http://www.briggsandstratton.com/eu/fr>
- <http://www.honda-engines-eu.com/fr/service-network-page;jsessionid=5EE8456CF39CD572AA2AEEDFD290CDAE>
- <https://www.rato-europe.com/it/service-network>

Please keep your original packaging to allow for after-sales service returns or pack your machine with a similar cardboard box of the same dimensions.

For any question concerning our after-sales service you can make a request on our website <https://services.swap-europe.com>

Our hotline remains available at +33 (9) 70 75 30 30.



WARRANTY EXCLUSIONS

THE WARRANTY DOES NOT COVER:

- Start-up and setting up of the product.
- Damage resulting from normal wear and tear of the product.
- Damage resulting from improper use of the product.
- Damage resulting from assembly or start-up not in accordance with the user manual.
- Breakdowns related to carburetion beyond 90 days and fouling of carburetors.
- Periodic and standard maintenance events.
- Actions of modification and dismantling that directly void the warranty.
- Products whose original authentication marking (brand, serial number) has been degraded, altered or withdrawn.
- Replacement of consumables.
- The use of non-original parts.
- Breakage of parts following impacts or projections.
- Accessories breakdowns.
- Defects and their consequences linked to any external cause.
- Loss of components and loss due to insufficient screwing.
- Cutting components and any damage related to the loosening of parts.
- Overload or overheating.
- Poor power supply quality: faulty voltage, voltage error, etc.
- Damages resulting from the deprivation of enjoyment of the product during the time necessary for repairs and more generally the costs related to the immobilization of the product.
- The costs of a second opinion established by a third party following an estimate by a SWAP-Europe repair station
- The use of a product which would show a defect or a breakage which was not the subject of an immediate report and/or repair with the services of SWAP-Europe.
- Deterioration linked to transport and storage*.
- Launchers beyond 90 days.
- Oil, petrol, grease.
- Damages related to the use of non-compliant fuels or lubricants.

* In accordance with transport legislation, damage related to transport must be declared to carriers within 48 hours maximum after observation by registered letter with acknowledgement of receipt.

This document is a supplement to your notice, a non-exhaustive list.

Attention: all orders must be checked in the presence of the delivery person. In case of refusal by the delivery person, it you must simply refuse the delivery and notify your refusal.

Reminder: the reserves do not exclude the notification by registered letter with acknowledgement within 72 hours.

Information:

Thermal devices must be wintered each season (service available on the SWAP-Europe site). Batteries must be charged before being stored.

HYUNDAI
POWER PRODUCTS

For Inquiries, please contact:

BUILDER SAS
32, Rue Aristide Bergès Z1 31270 Cugnaux, France
Tél.: +33(0)5.34.502.502 Fax : +33(0)5.34.502.503
<http://www.hyundai-power-fr.com/>
Fabriqué en République Populaire de Chine(PRC)

Importée par BUILDER SAS, France

Licensed by Hyundai Corporation Holdings, Korea